

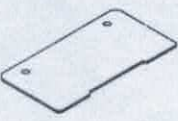

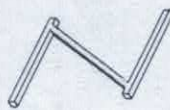









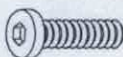





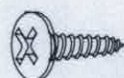

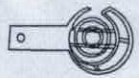

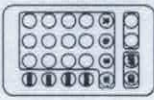
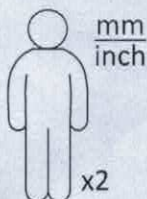



<p>Ax1</p> 	<p>Bx2</p> 	<p>Cx2</p> 	<p>Dx1</p> 	<p>Ex1</p> 
<p>Fx1</p> 	<p>Gx6</p> 	<p>Hx8</p> 	<p>Ix6</p> 	<p>Jx4</p> 
<p>Kx2</p> 	<p>Lx1</p> 	<p>Mx6</p> 	<p>Nx1</p> 	<p>Ox1</p> 
<p>Px1</p> 	<p>Qx1</p> 			

1

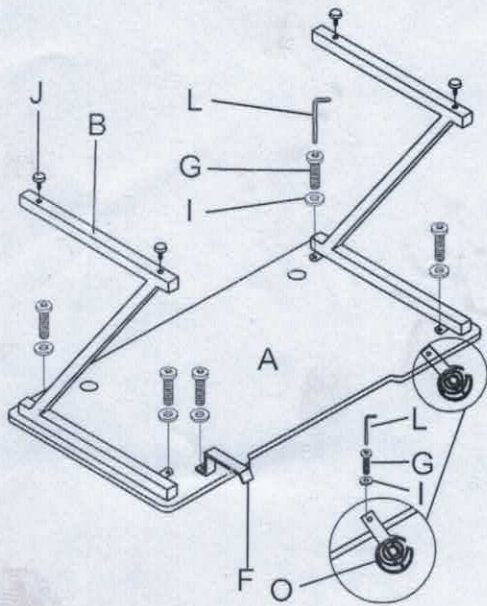
Ox1 	Lx1 	Gx6 	Ix6 
Jx4 	Bx2 	Fx1 	Ax1 



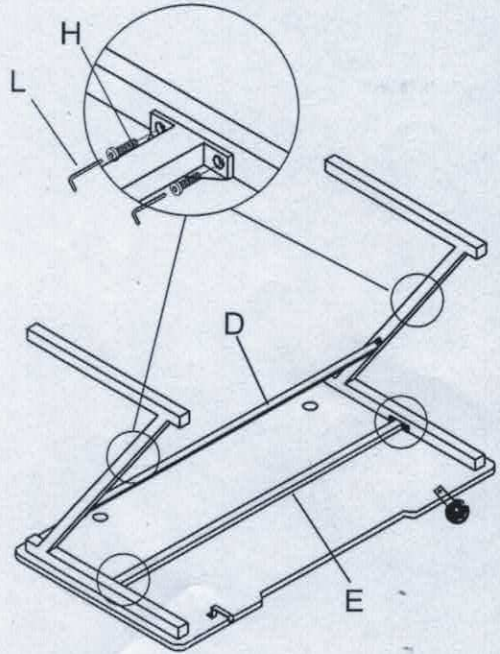

2

Lx1 	Hx8 	Dx2 	Ex1 
--	--	--	--



3

Px1 	Nx1 	Mx6 	Cx2 
--	--	--	--

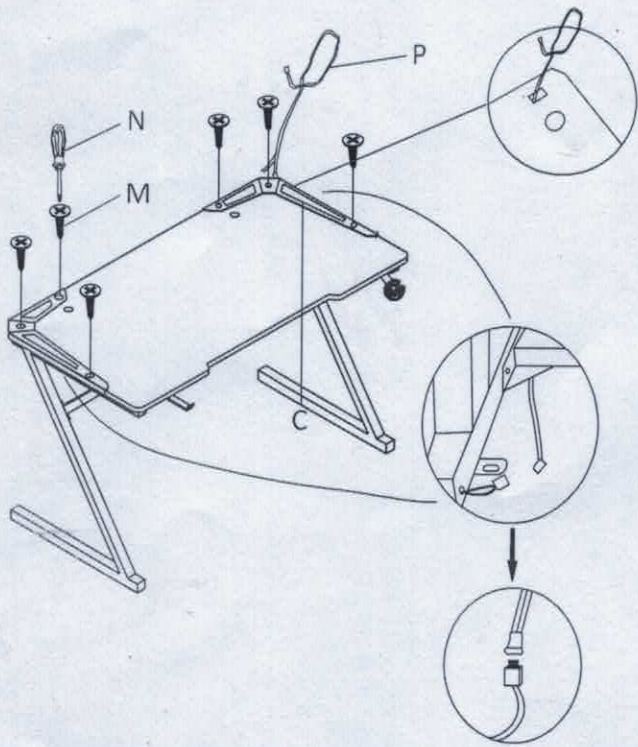

4

Kx2 
--

